

TNC-FLS-1200-01A

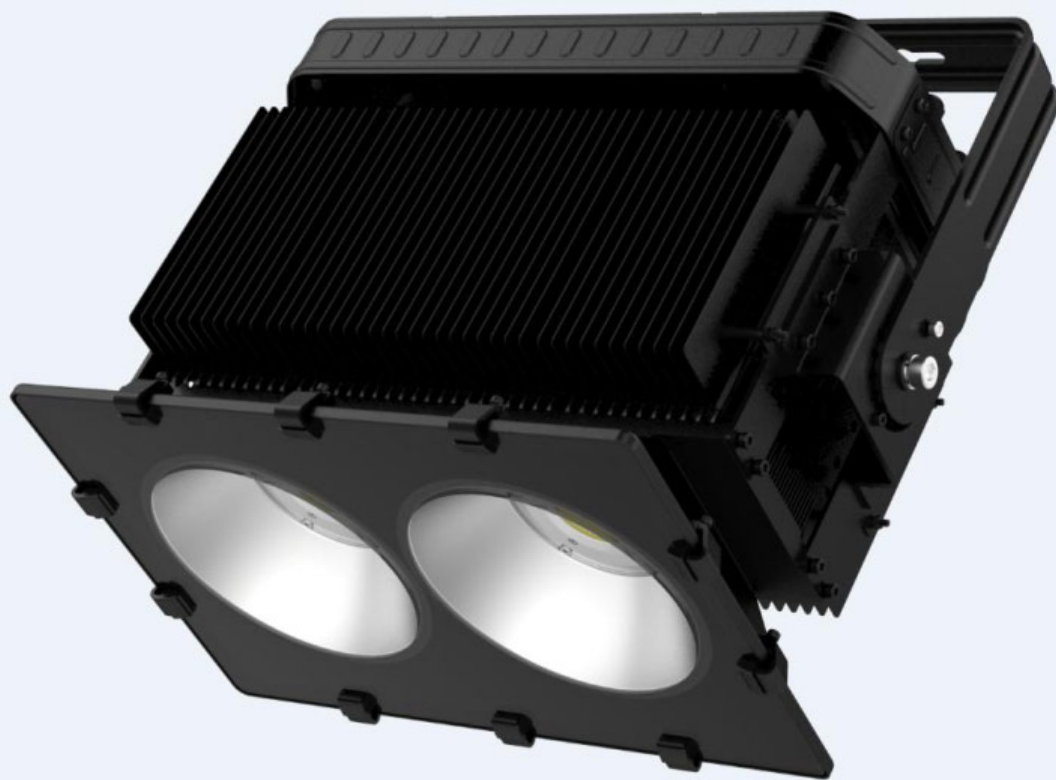

Product Name	产品名称	投光灯套件
Product NO	产品型号	TNC-FLS-1200-01A
File NO	文件编号	
Manual NO	版本号	A
Date	日期	2016.05.16





目录 Catalogue

产品照片	-----	1
物料清单	-----	2
配件爆炸图	-----	4
灯罩规格	-----	5
反光杯规格	-----	6
电源固定孔位	-----	7
灯罩固定孔位	-----	8
光杯固定孔位	-----	9
光源固定孔位	-----	10
支架孔位	-----	11
成品图	-----	12
包装方式	-----	13



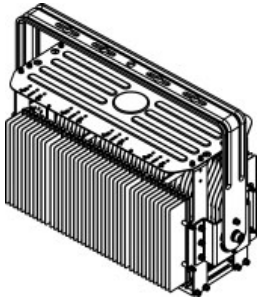

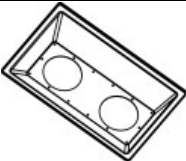
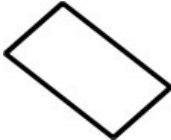
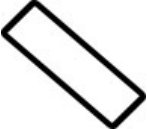
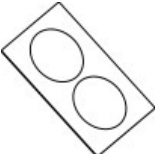



产品照片



物料清单

项次	图片	规格/用量
1		散热主体*1
2		电源罩A*2
3		电源罩B*2
4		方罩*1
5		方罩玻璃密封圈*1
6		方罩密封圈*1
7		方罩钢化玻璃*1
8		反光杯*2
9		玻璃夹扣*12

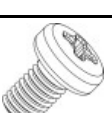
物料清单

项次	图片	规格/用量
10		接线防水套件 M13空心螺栓+硅胶套A+硅胶套B*4 注：客户可根据电源线尺寸选择使用其中一款硅胶套
		
		
11		光源压环*2 (选购) 需提供光源信息
12		光源美化环*2 (选购) 需提供光源信息
13		光源压环螺丝 (选购) M3*8圆头螺丝*8
14		反光杯固定螺丝 M4*6圆头螺丝*8
15		电源固定螺丝套件 M4*10圆头带介螺丝*24 M4法兰螺母*24
16		
17		方罩固定螺丝 M4*8圆头螺丝*14
18		电源罩固定螺丝-A M5X8圆头螺丝*8
19		电源罩固定螺丝-B M3*8圆头螺丝*4
20		电源罩防水接头PG9*4

配件爆炸图

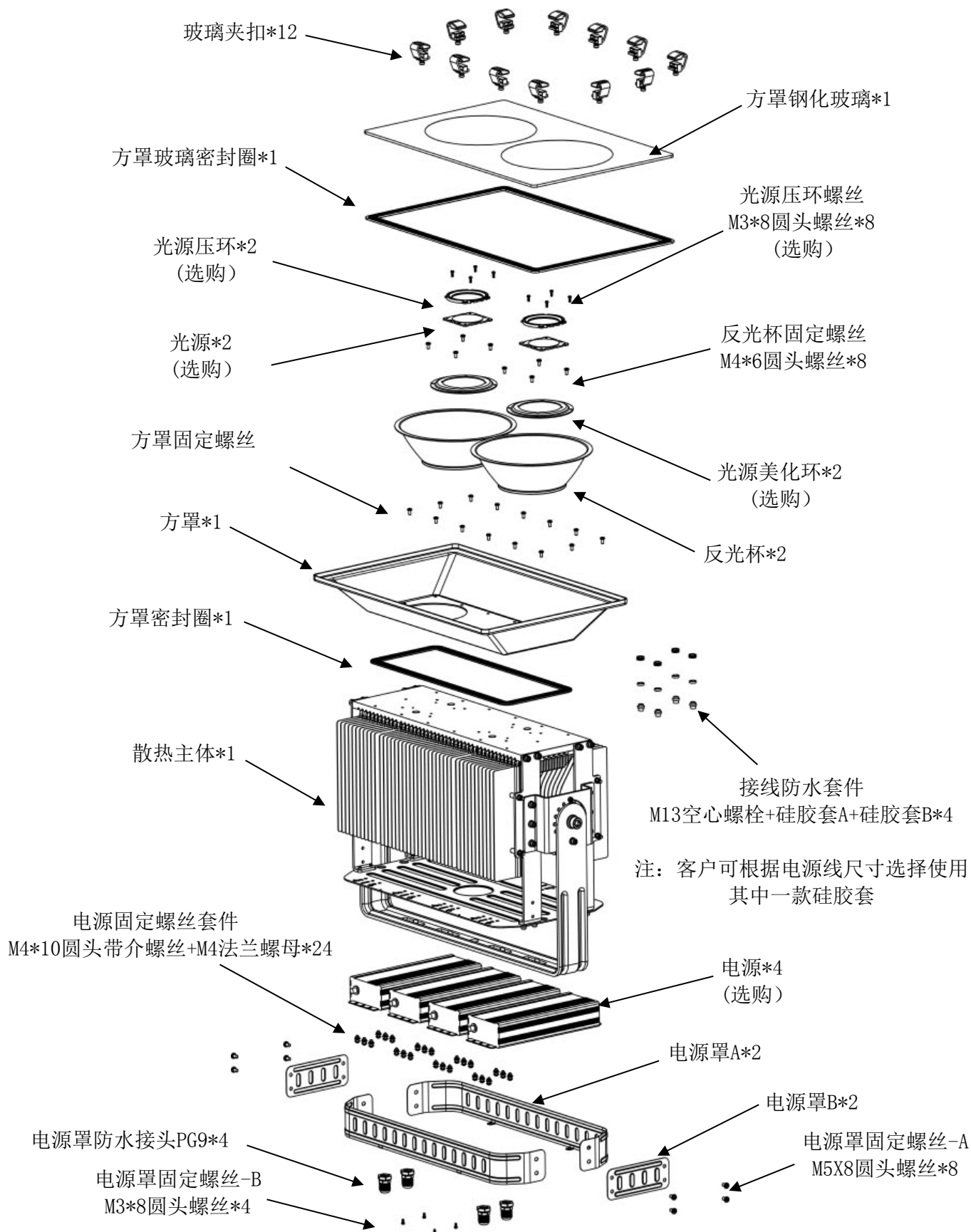

灯罩规格

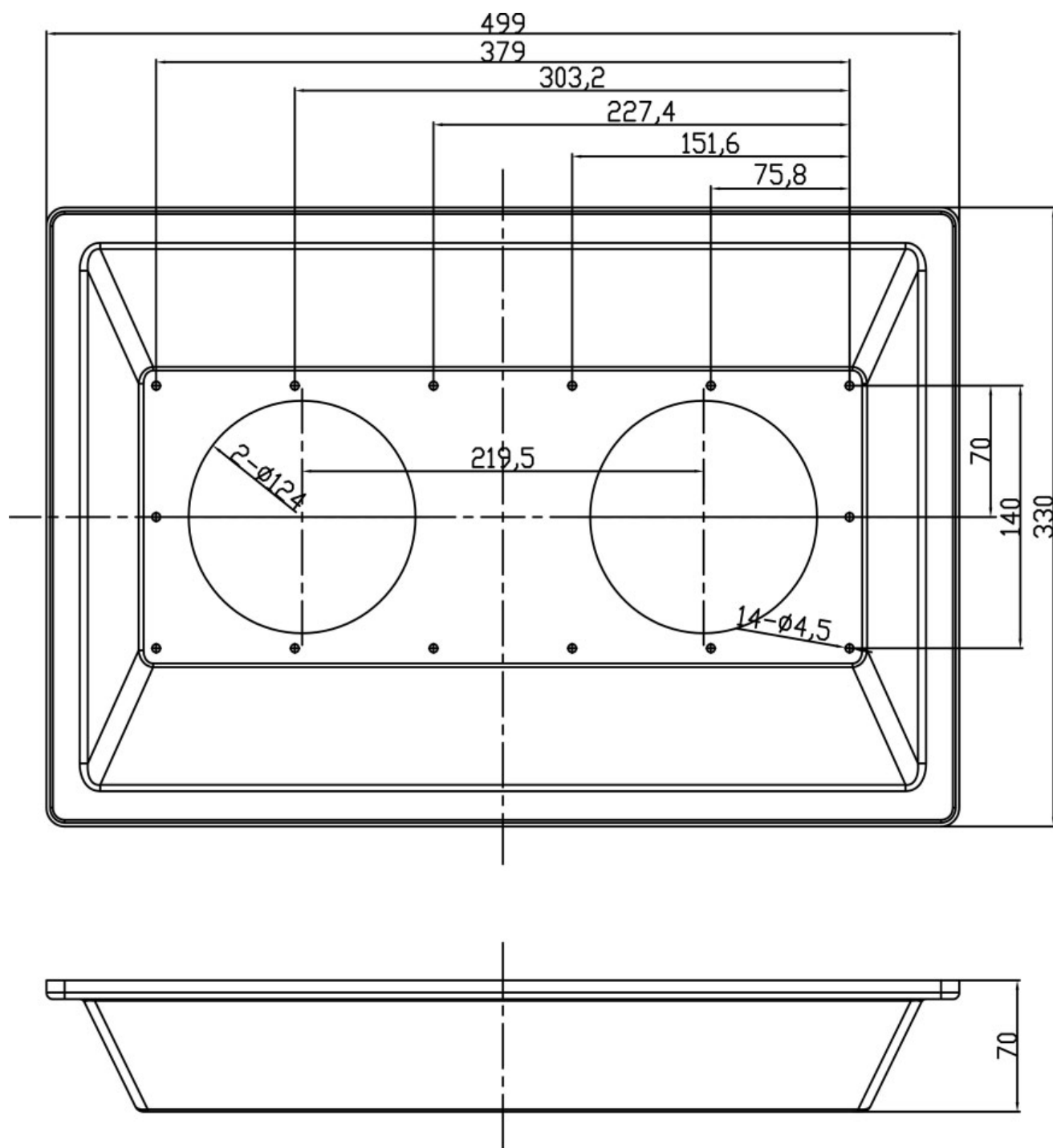

反光杯规格

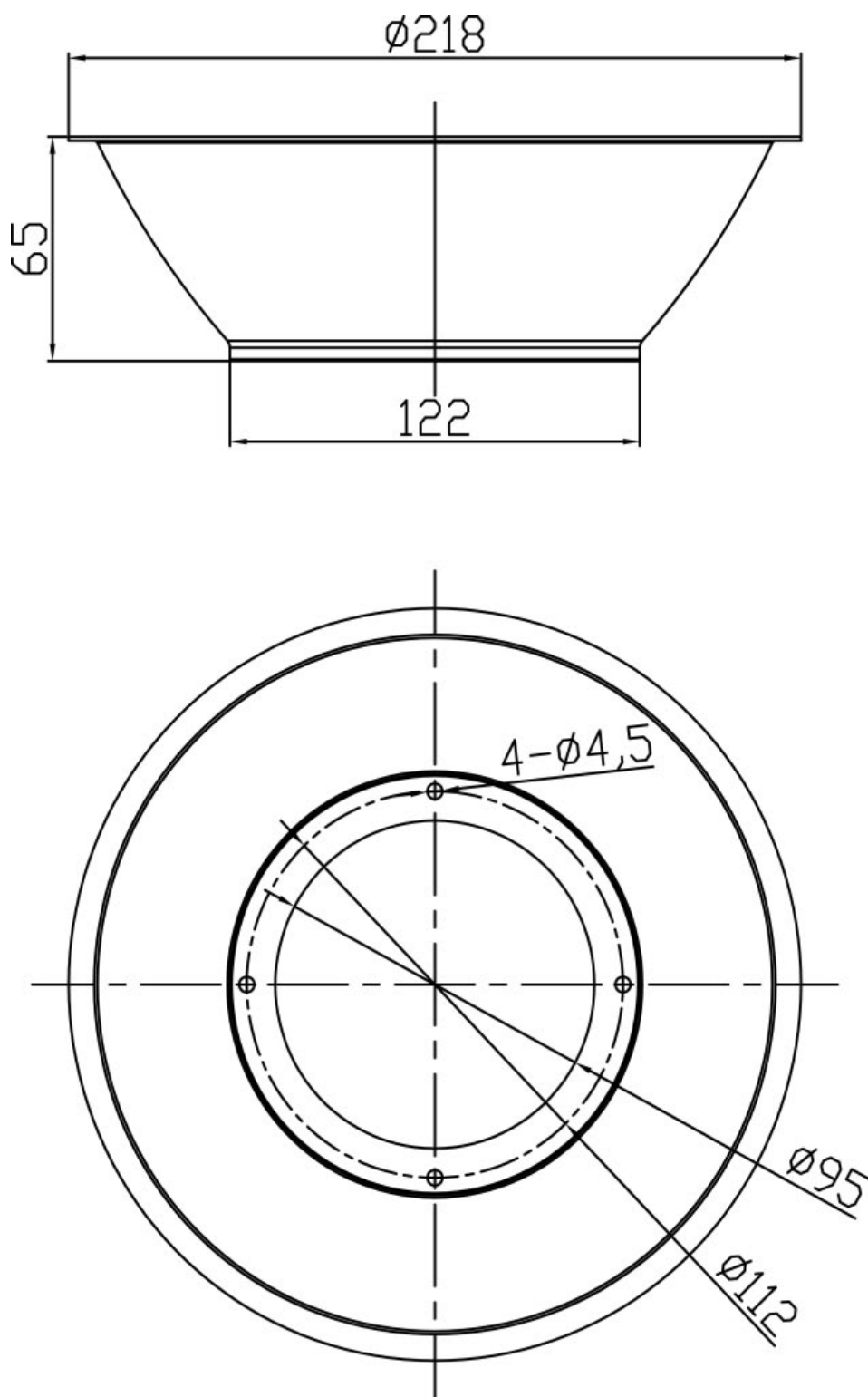

电源固定孔位

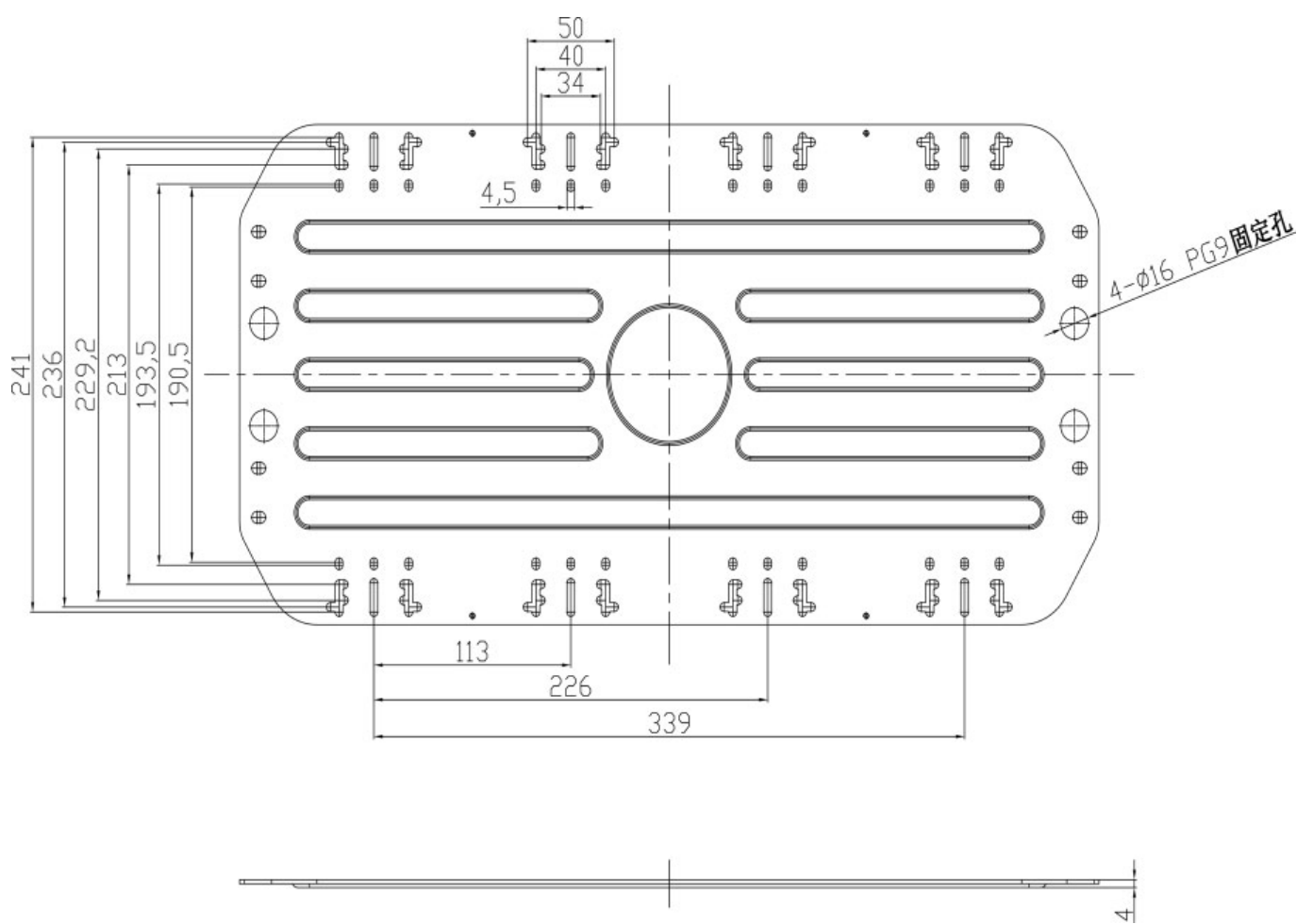

灯罩固定孔位

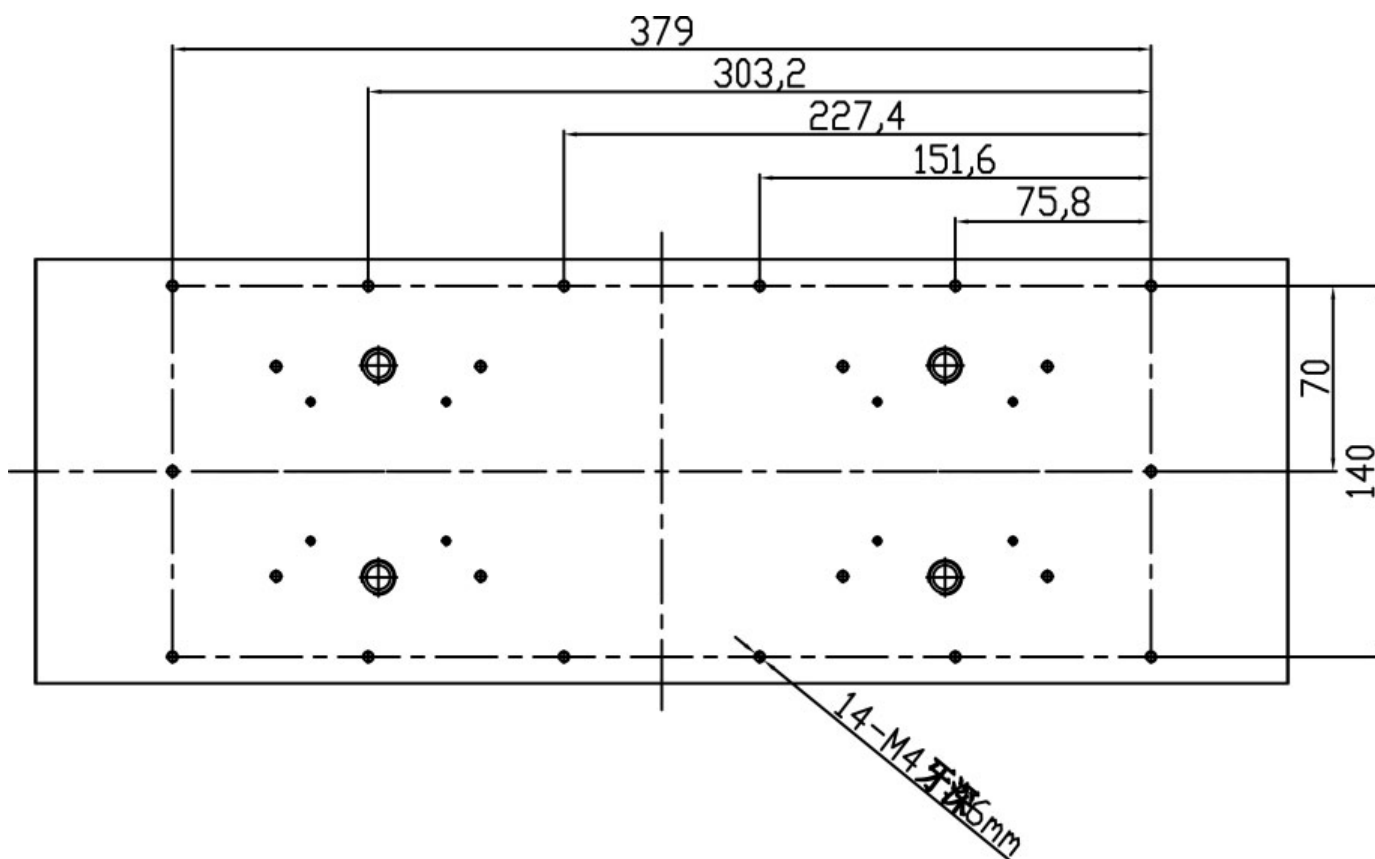

光杯固定孔位

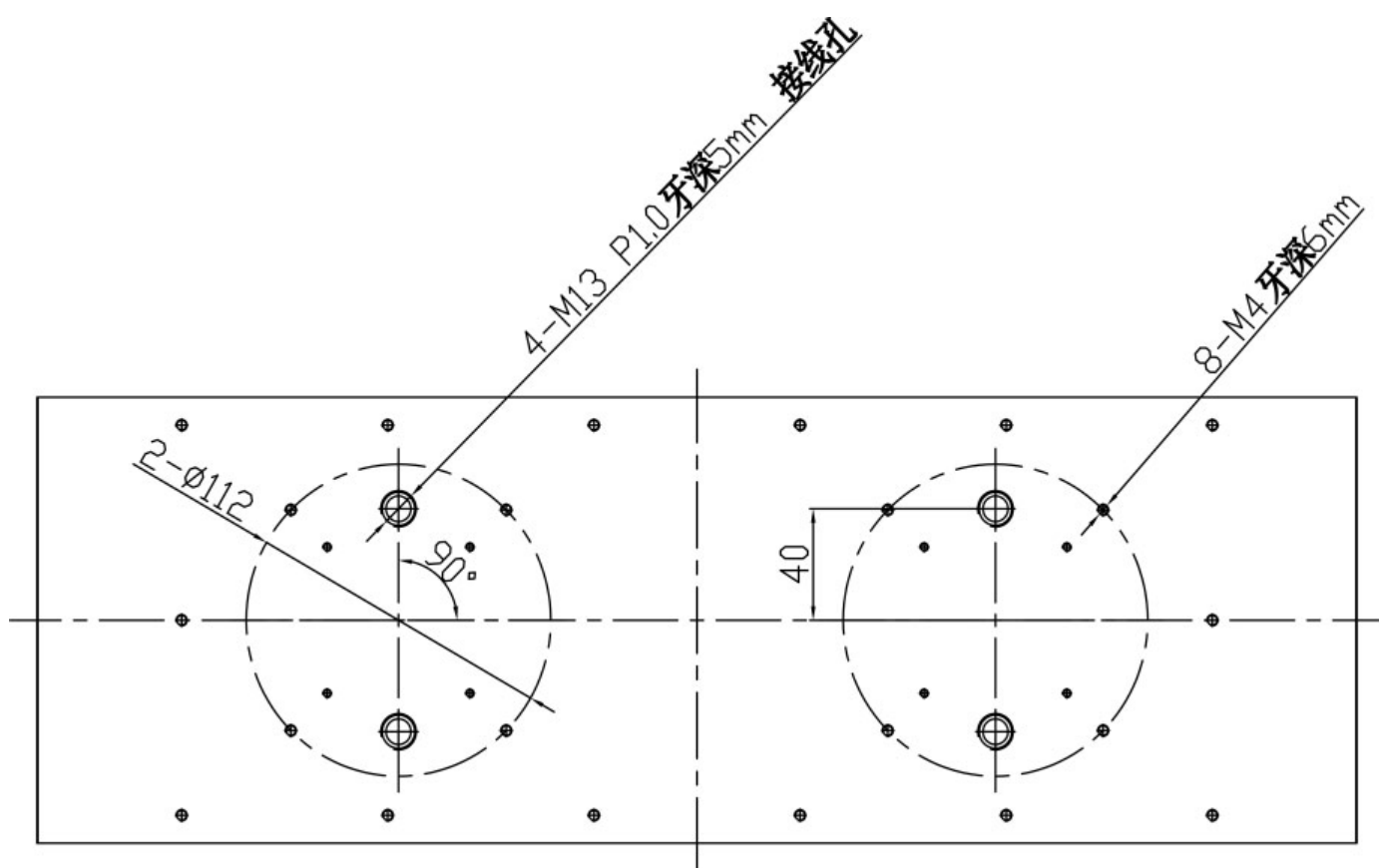

光源固定孔位

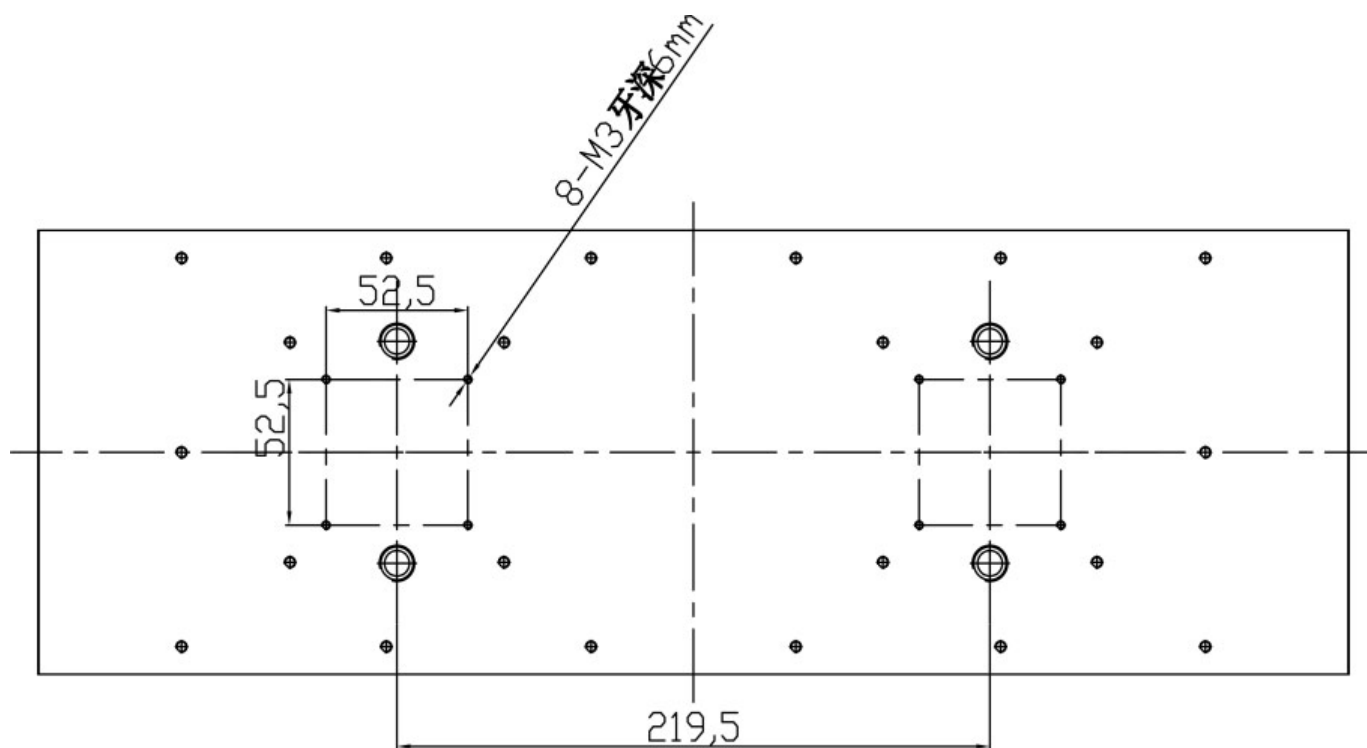

支架孔位

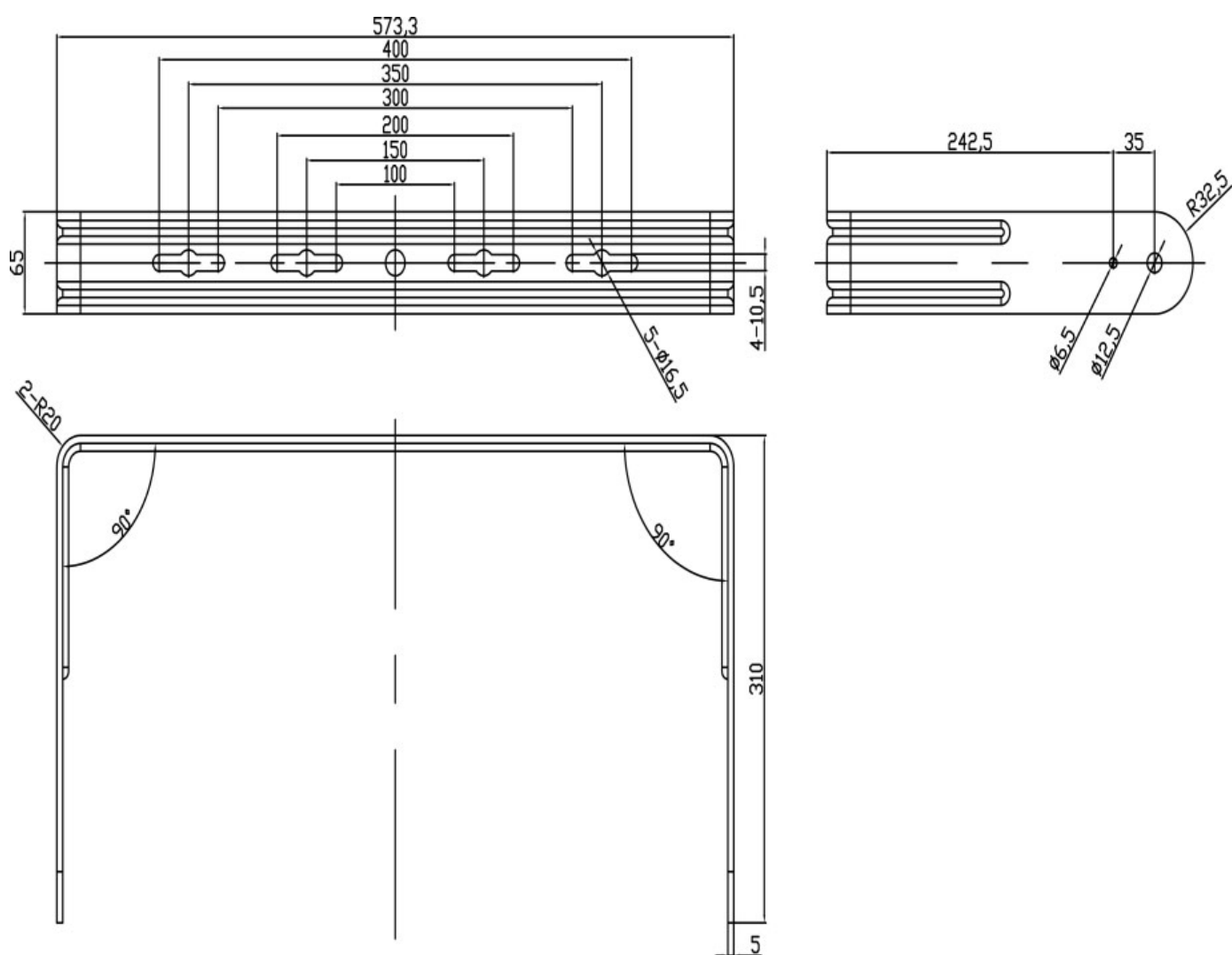

成品图

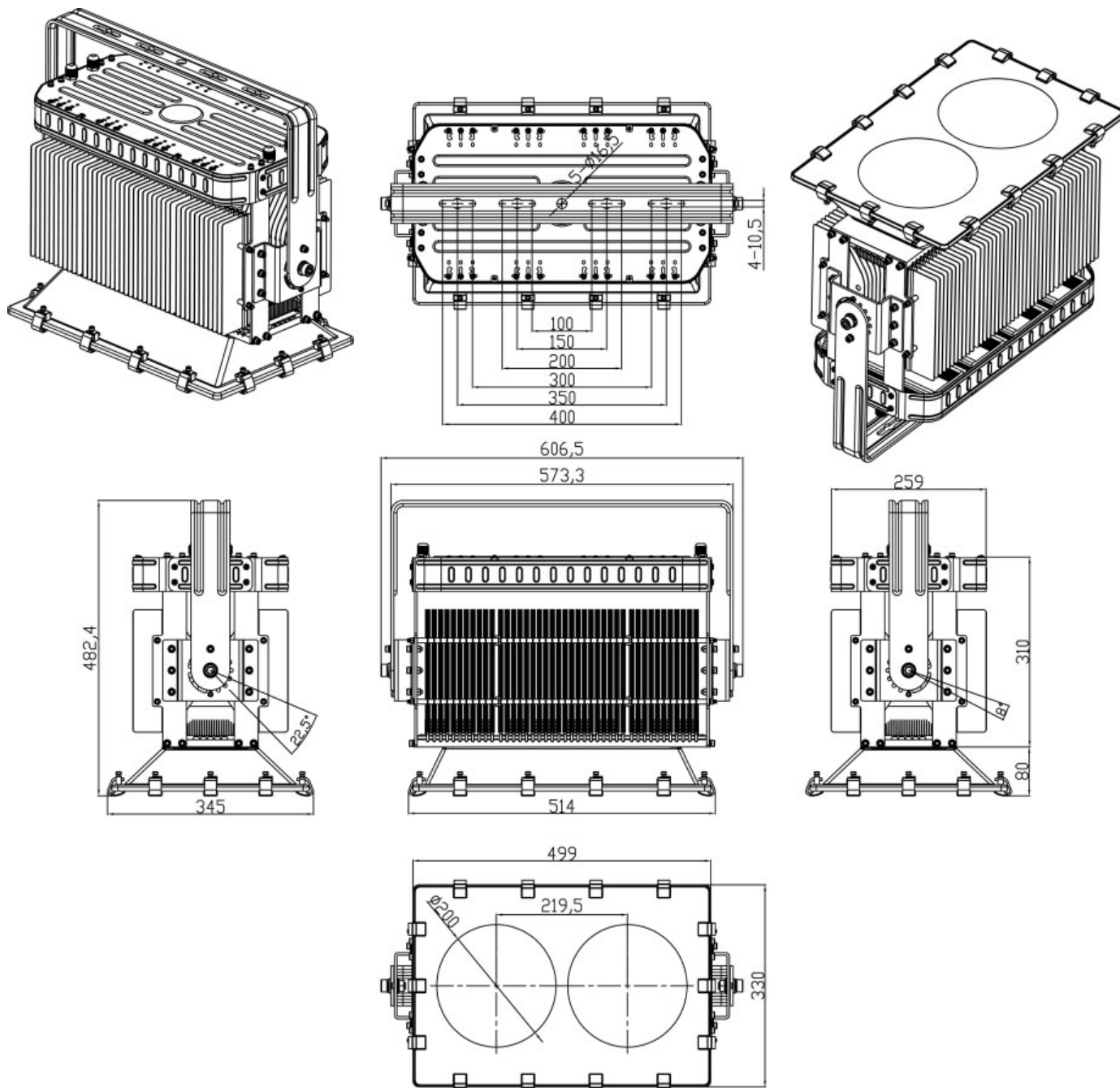

包装方式

1.包材 (Packaging material) : (注 : 整灯包装不含配件)

A : PE胶袋0.03(厚)x200x102mm (装4款装配件 : 光源压环螺丝、电源固定螺丝套件、接线防水套件、电源罩防水接头PG9)

B : PE胶袋0.03(厚)x220x190cm (装光源压环、光源美化环)

C : 629X495X474mm纸箱 (K=A坑纸)

625X491X90mm (珍珠棉A)、625X491X90mm (珍珠棉-B)

2. 数量 (QTY) : 1PCS/箱

毛重 : 26.6kg

净重 : 21.6kg

体积 : 629mmx495mmx474mm \approx 0.15m³

包装示意图

